

## METROPOLIS MONOPOINT SUSPENSION

### D201027-

base number    Color    Finish    Finish    Lens    Cable  
 Temperature    (Diamond)    (Triangle)    Options    Options

- To build a product code in our configurator select the specify button on the base model # product page
- To build a manual product code on this datasheet choose from the options listed below in blue font and add the suffix to the base model #

#### GENERAL

Series: Metropolis  
 Subseries: Metropolis Monopoint  
 Partner: Zaneen  
 Division: Design  
 Installation: Suspension  
 Product Type: Pendant  
 Mounting Location: Ceiling  
 Light Distribution: Downlight

#### PHYSICAL

Shape: Cylinder  
 Diameter (mm): 26  
 Diameter (in): 1  
 Height (mm): 800  
 Height (in): 31 1/2  
 Fixture Finish: [BLK / BRZ / IND](#)  
 Holder Finish: [BLK / BRZ / IND / WHI](#)  
 Fixture Material: Aluminum  
 Cable Details: [Black or Transparent - 3500mm / 137 13 /16"](#)  
 Upon Request: Cylinder height. Max. 1830 mm / 72". Min 153mm / 6".  
 Min. qty required 50 pcs.

#### ELECTRICAL

Lamp Type: LED  
 Input Wattage (W): 3.65  
 Total Output Wattage (W): 2.7  
 Dimming: Non-Dimmable  
 Driver Included: Yes  
 Driver Location: Integrated  
 Driver Type: Constant Current - Universal  
 Driver Class: Class 2  
 Input Voltage (V): 120 - 277  
 Constant Current (MA): 700  
 Upon Request: (Not included - see components) Remote: Phase dimming @120Vac only / 0-10Vdc dimming (dimming requires min. 3 fixtures)

#### LED

Number of LEDs: 1  
 Color Temperature (°K): [3000 / 4000](#)  
 Max. Delivered Lumen (lm): [114 / 122](#)  
 Nominal Lumen (lm): [124 / 133](#)  
 CRI: >90 CRI  
 Lamp Life (hrs): 50000  
 Upon Request: 3500K

#### OPTICAL

Optic°: [12 / 28 / 44](#)

#### RATINGS AND CERTIFICATIONS

Certified By: Certified for North American Standards  
 IP rating: IP41 (Damp)  
 Upon Request: Damp Rated for Exterior

PROJECT
TYPE
SPECIFIER
QUANTITY
DATE

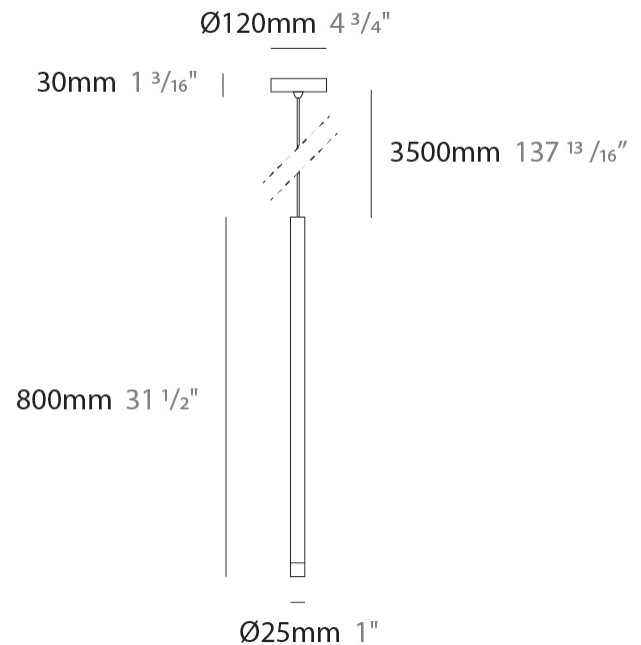

## METROPOLIS MONOPOINT SUSPENSION

D201027-

PROJECT
TYPE
SPECIFIER
QUANTITY
DATE

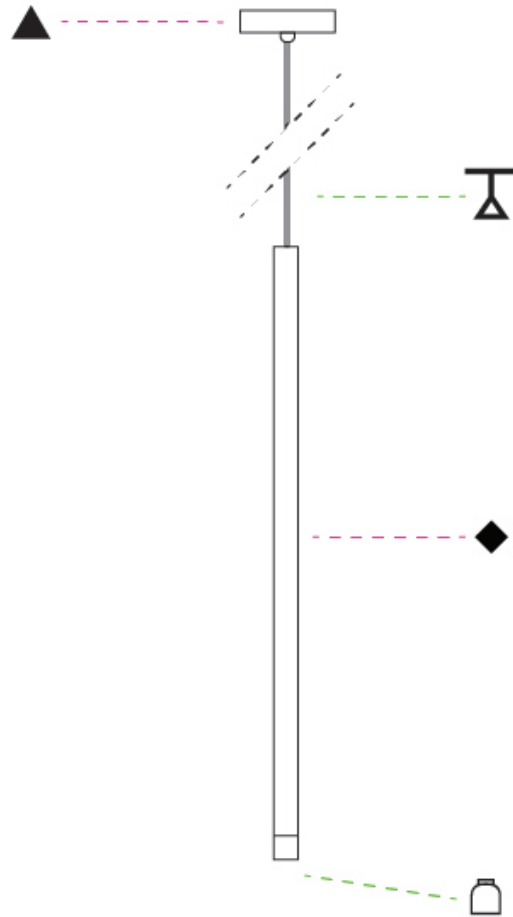

D

## METROPOLIS MONOPOINT SURFACE

### D202000-

base number      Color      Finish      Finish      Lens  
 Temperature      (Diamond)      (Triangle)      Options

- To build a product code in our configurator select the specify button on the base model # product page
- To build a manual product code on this datasheet choose from the options listed below in blue font and add the suffix to the base model #

#### GENERAL

Series: Metropolis  
 Subseries: Metropolis Monopoint  
 Partner: Zaneen  
 Division: Design  
 Installation: Surface  
 Product Type: Ceiling Surface  
 Mounting Location: Ceiling  
 Light Distribution: Downlight

#### PHYSICAL

Aperture Sizes - Downlights: 1"  
 Shape: Cylinder  
 Diameter (mm): 120  
 Diameter (in): 4 3/4  
 Height (mm): 500  
 Height (in): 19 11/16  
 Fixture Finish: [BLK / BRZ / IND](#)  
 Holder Finish: [BLK / BRZ / IND / WHI](#)  
 Fixture Material: Aluminum  
 Upon Request: Cylinder height. Max. 1830 mm / 72". Min 153mm / 6".  
 Min. qty required 50 pcs.

#### ELECTRICAL

Lamp Type: LED  
 Input Wattage (W): 3.65  
 Total Output Wattage (W): 2.7  
 Dimming: Non-Dimmable  
 Driver Included: Yes  
 Driver Location: Integrated  
 Driver Type: Constant Current - Universal  
 Driver Class: Class 2  
 Input Voltage (V): 120 - 277  
 Constant Current (MA): 700  
 Upon Request: (Not included - see components) Remote: Phase dimming @120Vac only / 0-10Vdc dimming (dimming requires min. 3 fixtures)

#### LED

Number of LEDs: 1  
 Color Temperature (°K): [3000 / 4000](#)  
 Nominal Lumen (lm): 124 / 133  
 CRI: >90 CRI  
 Lamp Life (hrs): 50000  
 Upon Request: 3500K

#### OPTICAL

Optic°: [12 / 28 / 44](#)

#### RATINGS AND CERTIFICATIONS

Certified By: Certified for North American Standards  
 IP rating: IP41 (Damp)  
 Upon Request: Damp Rated for Exterior

PROJECT
TYPE
SPECIFIER
QUANTITY
DATE

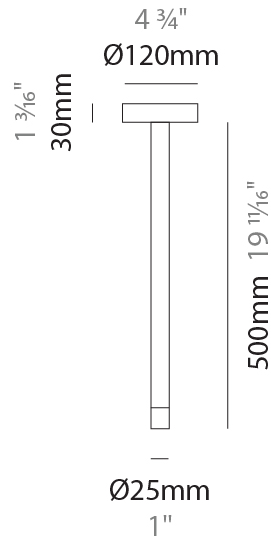

## METROPOLIS MONOPOINT SURFACE

D202000-

PROJECT

TYPE

SPECIFIER

QUANTITY

DATE

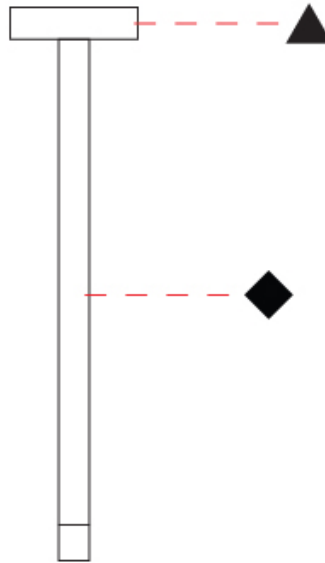

D

## METROPOLIS MONOPOINT SURFACE

### D202001-

base number    Color    Finish    Finish    Lens  
 Temperature    (Diamond)    (Triangle)    Options

- To build a product code in our configurator select the specify button on the base model # product page
- To build a manual product code on this datasheet choose from the options listed below in blue font and add the suffix to the base model #

#### GENERAL

Series: Metropolis  
 Subseries: Metropolis Monopoint  
 Partner: Zaneen  
 Division: Design  
 Installation: Surface  
 Product Type: Ceiling Surface  
 Mounting Location: Ceiling  
 Light Distribution: Downlight

#### PHYSICAL

Aperture Sizes - Downlights: 1"  
 Shape: Cylinder  
 Diameter (mm): 120  
 Diameter (in): 4 3/4"  
 Height (mm): 800  
 Height (in): 31 1/2"  
 Fixture Finish: [BLK / BRZ / IND](#)  
 Holder Finish: [BLK / BRZ / IND / WHI](#)  
 Fixture Material: Aluminum  
 Upon Request: Cylinder height. Max. 1830 mm / 72". Min 153mm / 6".  
 Min. qty required 50 pcs.

#### ELECTRICAL

Lamp Type: LED  
 Input Wattage (W): 3.65  
 Total Output Wattage (W): 2.7  
 Dimming: Non-Dimmable  
 Driver Included: Yes  
 Driver Location: Integrated  
 Driver Type: Constant Current - Universal  
 Driver Class: Class 2  
 Input Voltage (V): 120 - 277  
 Constant Current (MA): 700  
 Upon Request: (Not included - see components) Remote: Phase dimming @120Vac only / 0-10Vdc dimming (dimming requires min. 3 fixtures)

#### LED

Number of LEDs: 1  
 Color Temperature (°K): [3000 / 4000](#)  
 Nominal Lumen (lm): 124 / 133  
 CRI: >90 CRI  
 Lamp Life (hrs): 50000  
 Upon Request: 3500K

#### OPTICAL

Optic°: [12 / 28 / 44](#)

#### RATINGS AND CERTIFICATIONS

Certified By: Certified for North American Standards  
 IP rating: IP41 (Damp)  
 Upon Request: Damp Rated for Exterior

PROJECT
TYPE
SPECIFIER
QUANTITY
DATE

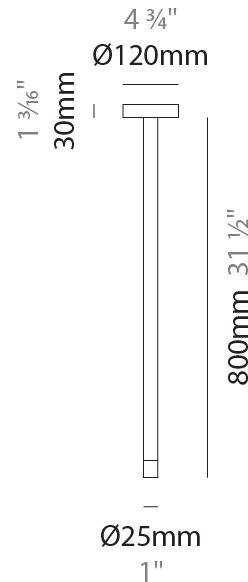

## METROPOLIS MONOPOINT SURFACE

D202001-

PROJECT

TYPE

SPECIFIER

QUANTITY

DATE

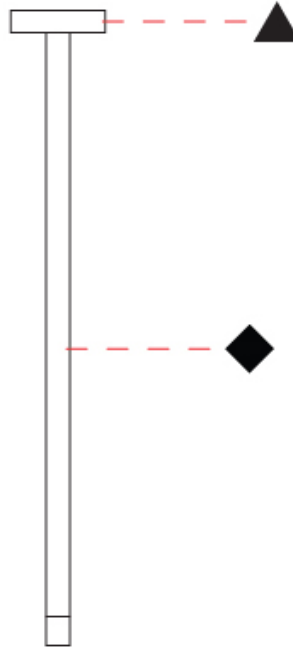

D

## METROPOLIS MONOPOINT SURFACE

### D202004-

base number      Color      Finish      Finish      Lens  
 Temperature      (Diamond)      (Triangle)      Options

- To build a product code in our configurator select the specify button on the base model # product page
- To build a manual product code on this datasheet choose from the options listed below in blue font and add the suffix to the base model #

#### GENERAL

Series: Metropolis  
 Subseries: Metropolis Monopoint  
 Partner: Zaneen  
 Division: Design  
 Installation: Surface  
 Product Type: Ceiling Surface  
 Mounting Location: Ceiling  
 Light Distribution: Downlight

#### PHYSICAL

Aperture Sizes - Downlights: 1"  
 Shape: Cylinder  
 Diameter (mm): 80  
 Diameter (in): 3 1/8"  
 Height (mm): 500  
 Height (in): 19 11/16"  
 Fixture Finish: [BLK / BRZ / IND](#)  
 Holder Finish: [BLK / BRZ / IND / WHI](#)  
 Fixture Material: Aluminum  
 Upon Request: Cylinder height. Max. 1830 mm / 72". Min 153mm / 6".  
 Min. qty required 50 pcs.

#### ELECTRICAL

Lamp Type: LED  
 Input Wattage (W): 3.65  
 Total Output Wattage (W): 2.7  
 Dimming: Non-Dimmable  
 Driver Included: Yes  
 Driver Location: Integrated  
 Driver Type: Constant Current - Universal  
 Driver Class: Class 2  
 Input Voltage (V): 120 - 277  
 Constant Current (MA): 700  
 Upon Request: (Not included - see components) Remote: Phase dimming @120Vac only / 0-10Vdc dimming (dimming requires min. 3 fixtures)

#### LED

Number of LEDs: 1  
 Color Temperature (°K): [3000 / 4000](#)  
 Nominal Lumen (lm): 124 / 133  
 CRI: >90 CRI  
 Lamp Life (hrs): 50000  
 Upon Request: 3500K

#### OPTICAL

Optic°: [12 / 28 / 44](#)

#### RATINGS AND CERTIFICATIONS

Certified By: Certified for North American Standards  
 IP rating: IP41 (Damp)  
 Upon Request: Damp Rated for Exterior

PROJECT
TYPE
SPECIFIER
QUANTITY
DATE

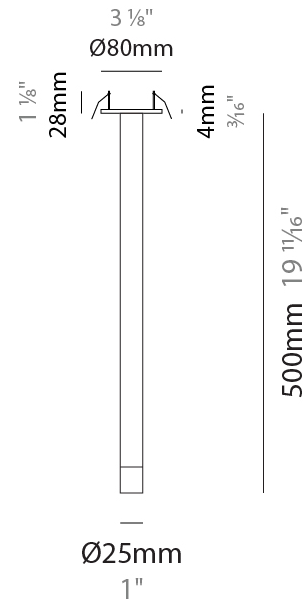
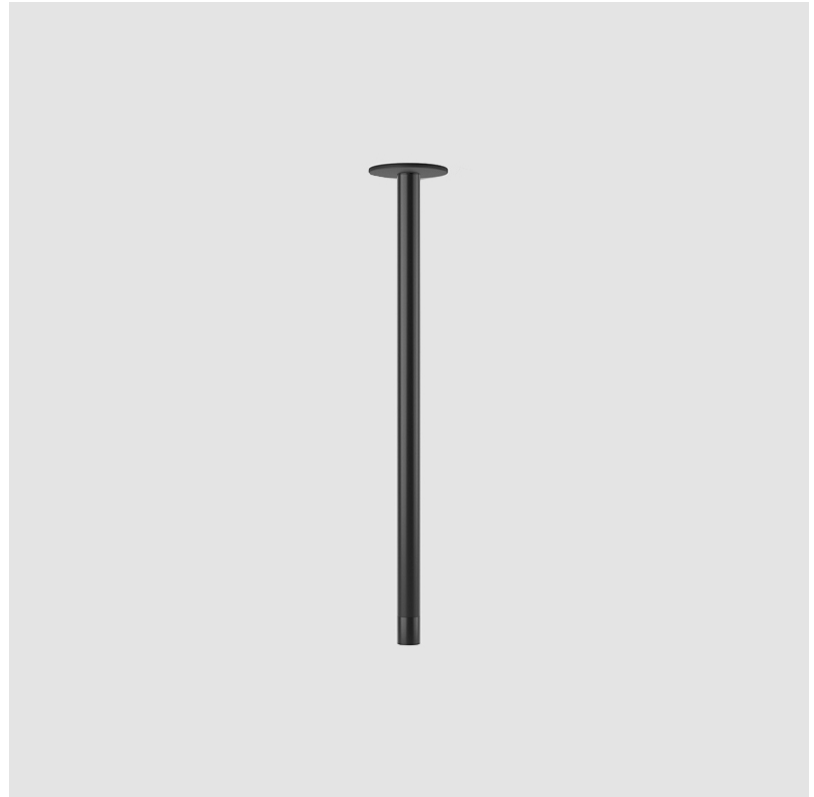

## METROPOLIS MONOPOINT SURFACE

D202004-

PROJECT

TYPE

SPECIFIER

QUANTITY

DATE

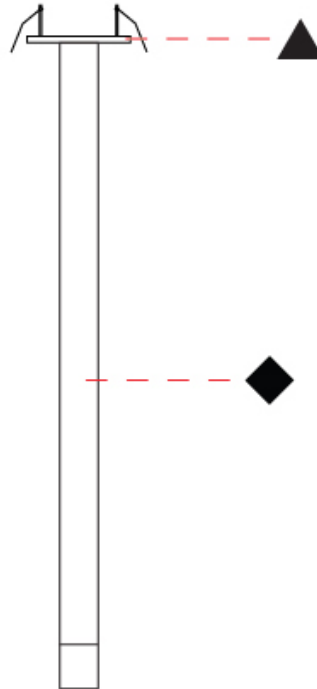

D

## METROPOLIS MONOPOINT SURFACE

### D202005-

base number    Color    Finish    Finish    Lens  
 Temperature    (Diamond)    (Triangle)    Options

- To build a product code in our configurator select the specify button on the base model # product page
- To build a manual product code on this datasheet choose from the options listed below in blue font and add the suffix to the base model #

#### GENERAL

Series: Metropolis  
 Subseries: Metropolis Monopoint  
 Partner: Zaneen  
 Division: Design  
 Installation: Surface  
 Product Type: Ceiling Surface  
 Mounting Location: Ceiling  
 Light Distribution: Downlight

#### PHYSICAL

Aperture Sizes - Downlights: 1"  
 Shape: Cylinder  
 Diameter (mm): 80  
 Diameter (in): 3 1/8"  
 Height (mm): 800  
 Height (in): 31 1/2"  
 Fixture Finish: [BLK / BRZ / IND](#)  
 Holder Finish: [BLK / BRZ / IND / WHI](#)  
 Fixture Material: Aluminum  
 Upon Request: Cylinder height. Max. 1830 mm / 72". Min 153mm / 6".  
 Min. qty required 50 pcs.

#### ELECTRICAL

Lamp Type: LED  
 Input Wattage (W): 3.65  
 Total Output Wattage (W): 2.7  
 Dimming: Non-Dimmable  
 Driver Included: Yes  
 Driver Location: Integrated  
 Driver Type: Constant Current - Universal  
 Driver Class: Class 2  
 Input Voltage (V): 120 - 277  
 Constant Current (MA): 700  
 Upon Request: (Not included - see components) Remote: Phase dimming @120Vac only / 0-10Vdc dimming (dimming requires min. 3 fixtures)

#### LED

Number of LEDs: 1  
 Color Temperature (°K): [3000 / 4000](#)  
 Nominal Lumen (lm): 124 / 133  
 CRI: >90 CRI  
 Lamp Life (hrs): 50000  
 Upon Request: 3500K

#### OPTICAL

Optic°: [12 / 28 / 44](#)

#### RATINGS AND CERTIFICATIONS

Certified By: Certified for North American Standards  
 IP rating: IP41 (Damp)  
 Upon Request: Damp Rated for Exterior

PROJECT
TYPE
SPECIFIER
QUANTITY
DATE

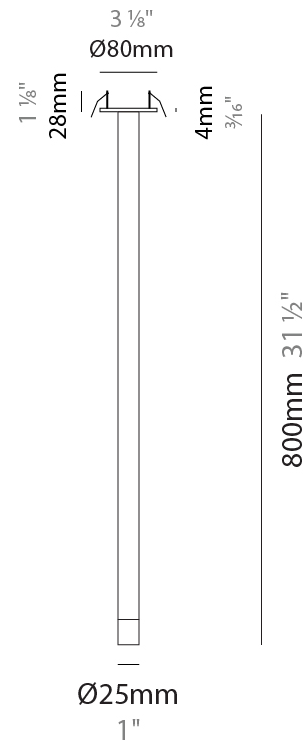
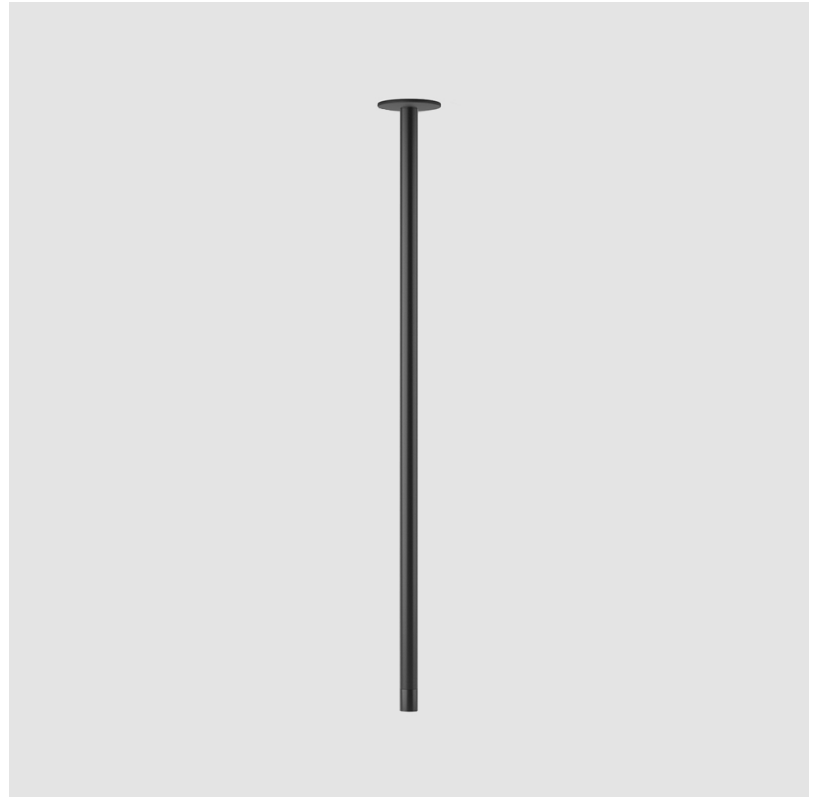

## METROPOLIS MONOPOINT SURFACE

D202005-

PROJECT	_____
TYPE	_____
SPECIFIER	_____
QUANTITY	_____
DATE	_____

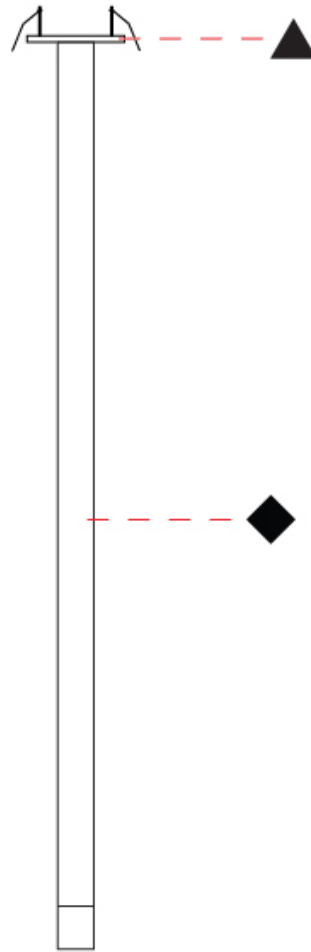

D

PROJECT	_____
TYPE	_____
SPECIFIER	_____
QUANTITY	_____
DATE	_____

### Fixture Finish

Black - BLK

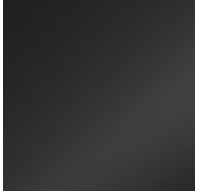

Bronze - BRZ

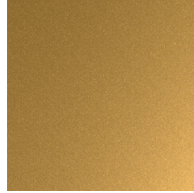

Industrial - IND



### Holder Finish

Black - BLK

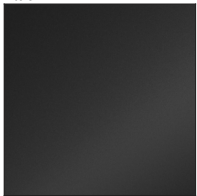

Bronze - BRZ

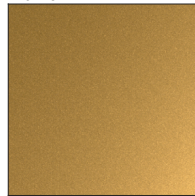

Industrial - IND

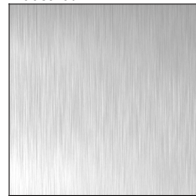

White - WHI



**Digital:** Not all screens are calibrated the same, and therefore, colors will appear differently between screens.

**Physical:** When texture is involved, there will be variations in color, character and tone within a product series and between product families.



### LEGEND

	floor-mounted		pivotable		special LED (upon request) RGB, RGBW, tunable, gold+, meat+, art+, fashion+
	wall and ceiling: recessed and surface mounted		rotating		warm dim / natural dimming LED
	ceiling-mounted and wall-mounted		illuminate tilted		rechargeable battery powered
	wall-mounted		color of suspension cable		fixture with natural vivid LED (upon request)
	omni-directional light distribution		length of suspension cable		color rendering index
	direct light distribution		reflector degree selection		color temperature
	direct/indirect light distribution		super spot		lumen (luminous flux)
	indirect light distribution		lens		efficacy (lumens per watt)
	asymmetric light distribution		lens pack		Unified Glare Rating (UGR) range from 5-40
	aura light distribution		shine ring		marine grade (AISI 316 stainless steel)
	round wall or ceiling cut-out		integrated shine ring with diffuser		walk on
	square wall or ceiling cut-out		free individual colors 01-29		drive on
	the supplied jig specifies the cutout dimensions		individual colors: 00 (free of charge), 01-25 (extra charge)		Dark Sky Compliance
	minimum distance (meters) lamp - object		luminaire part to be colored (F1)		Americans with Disabilities Act (less than 4" off the wall located between 27"-84" from floor)
	recessed depth		luminaire part to be colored (F2)		lamp protected against explosion
	ceiling thickness in mm		luminaire part to be colored (F3)		blown glass using traditional methods by master glass blower
	ceiling thickness selection		luminaire part to be colored (F4)		acoustic material
	dimnable DP (phase), DV (0-10V), DD (dali), DS (step-dim)		luminaire part to be colored (F5)		protection class I, protection insulation
	included or excluded LED driver/transformer/control gear		color of 3-circuit adaptor		protection class II, protection insulation
	separately switchable		indirect diffuser		ETL Certified to UL and CSA Standards
	sensor		direct diffuser		UL Certified to UL and CSA Standards
	remote control		ball-proof (upon request)		CSA Certified to UL and CSA Standards
	available upon request		accessory		Certified for North American Standards

### IP RATING

	protected against ingress of solid bodies greater than 12.5mm (finger)
	protected against ingress of solid bodies greater than 2.5mm protected against sprays of water up to 60 degrees from the vertical (rain)
	protected against ingress of solid bodies greater than 1mm (wire) no protection against the ingress of moisture
	protected against ingress of solid bodies greater than 1mm (wire) protected against sprays of water up to 60 degrees from the vertical (rain)
	protected against ingress of solid bodies greater than 1mm (wire) protected against water splashed from all directions
	protected against limited ingress of dust (wet rooms/covered outdoor areas) protected against water splashed from all directions
	protected against ingress of dust protected against jets of water
	protected against ingress of dust protected against powerful jets of water or heavy seas
	protected against ingress of dust protected against immersion of water between 15cm - 1m for 30 minutes
	protected against ingress of dust protected against immersion of water under pressure for long periods

### IK RATING

	protected against 0.14 joules impact (equivalent to 0.25kg mass dropped from 56mm above the surface)
	protected against 0.2 joules impact (equivalent to 0.25kg mass dropped from 80mm above the surface)
	protected against 0.35 joules impact (equivalent to 0.25kg mass dropped from 140mm above the surface)
	protected against 0.5 joules impact (equivalent to 0.25kg mass dropped from 200mm above the surface)
	protected against 0.7 joules impact (equivalent to 0.25kg mass dropped from 280mm above the surface)
	protected against 1 joules impact (equivalent to 0.25kg mass dropped from 400mm above the surface)
	protected against 2 joules impact (equivalent to 0.5kg mass dropped from 400mm above the surface)
	protected against 5 joules impact (equivalent to 1.7kg mass dropped from 300mm above the surface)
	protected against 10 joules impact (equivalent to 5.0kg mass dropped from 200mm above the surface)
	protected against 20 joules impact (equivalent to 5.0kg mass dropped from 400mm above the surface)